

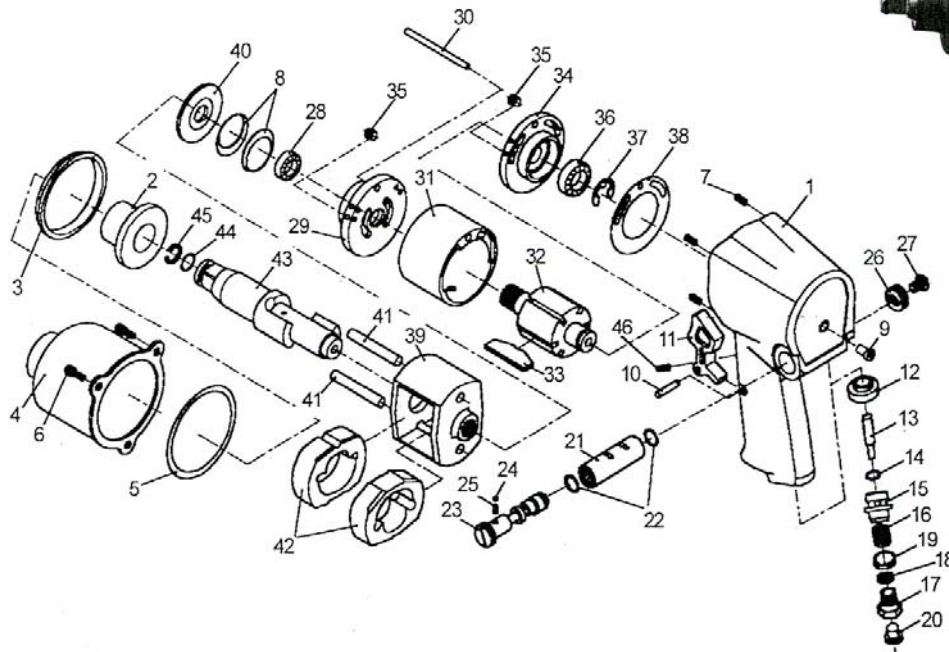

W501B, W501B-2 & W501B-P 1/2" IMPACT WRENCH

Wespro Pneumatic Tools



* Tune Up Kit Order Code #178550

<u>No.</u>	<u>Description</u>	<u>Order Code</u>	<u>Qty</u>	<u>No.</u>	<u>Description</u>	<u>Order Code</u>	<u>Qty</u>
1	Motor Housing	147390	1	25	Spring	147409	1
2	Hammer Case Bushing	143185	1	26	Reverse Valve Knob	65621	1
3	Hammer Case Pilot	147391	1	27	Screw Reverse Valve	147410	1
4	Hammer Case	147392	1	28	Ball Bearing	112673	1
5	Hammer Case Gasket	65620	1	29	Front End Plate	65622	1
6	Hammer Case Cap Screw	147393	3	30	Cylinder Pin	147412	1
7	Insert Self Tap	147394	3	31	Cylinder	147413	2
8	Washer Motor Clamp	147395	2	32	Rotor	146425	1
9	Grease Fitting	147396	1	33	Rotor Blade	147031	6
10	Trigger Pin	147397	1	34	Rear End Plate	145715	1
11	Trigger	147398	1	35	Aluminum Plug	147414	8
12	Throttle Valve Ring	147399	1	36	Ball Bearing	112029	1
13	Throttle Valve Stem	147400	1	37	E-Ring	147416	1
14	O-Ring	143188	1	38	Rear End Plate Gasket	147036	1
15	Throttle Valve	147401	1	39	Hammer Frame	65623	1
16	Throttle Valve Spring	65619	1	40	Washer Hammer Frame Rear	143317	1
17	Air Strainer Assembly	146211	1	41	Hammer Pin	65624	2
18	Filter Net	-	1	42	Hammer	146426	2
19	Washer	-	1	43A	Anvil Assembly (Standard)	143186	1
20	Dust Cover	-	1	43B	Anvil Assembly 2" Extended	143187	1
21	Reverse Valve Bushing	147405	1	43C	Anvil Assembly Pin Type	172564	1
22	O-Ring	147406	2	44	O-Ring	143188	1
23	Reverse Valve	147407	1	45	Socket Retainer	145721	1
24	Steel Ball	147408	1	46	Tapered Screw	147417	1