

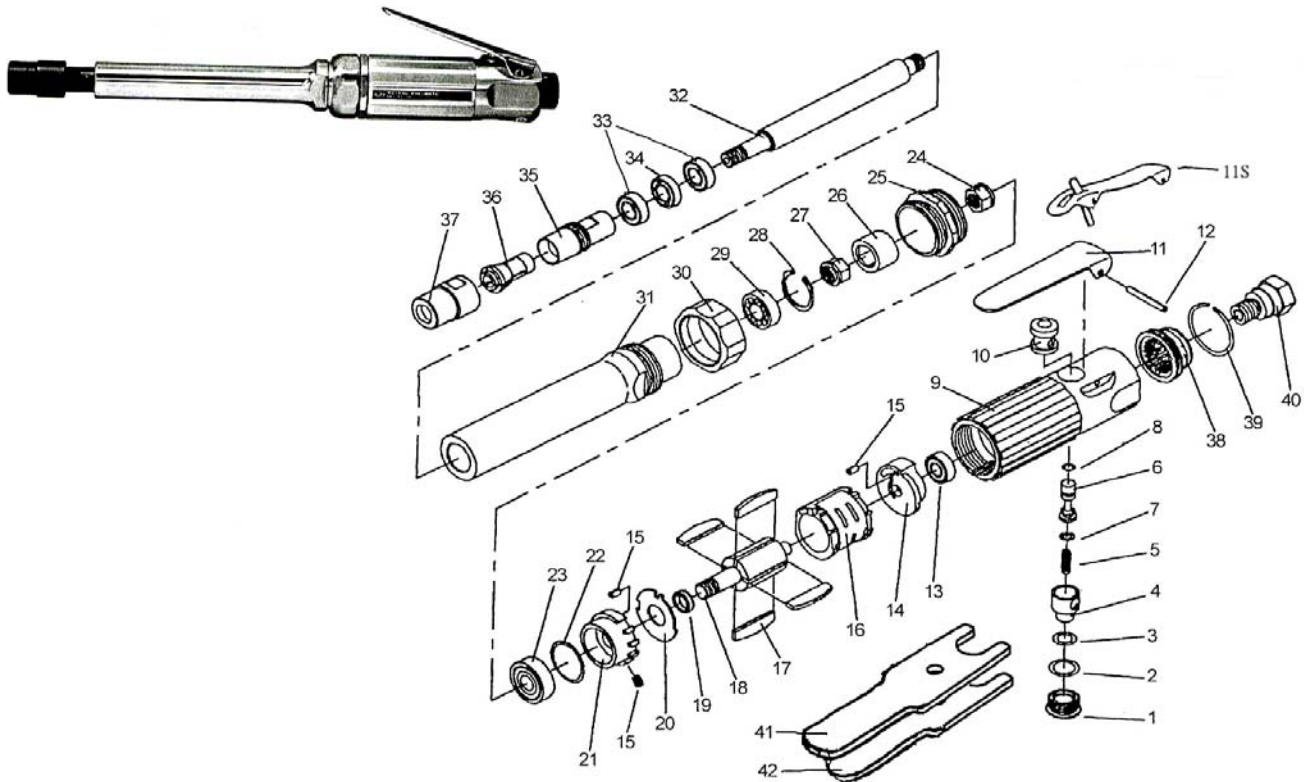

HDG25-3RX5L & 3RX5S EXTENDED HEAVY DUTY DIE GRINDER

Wespro Pneumatic Tools



<u>No.</u>	<u>Description</u>	<u>Order Code</u>	<u>Qty</u>	<u>No.</u>	<u>Description</u>	<u>Order Code</u>	<u>Qty</u>
1	Plug Screw	132304	1	22	Shim Pack	110745	0-2
2	O-Ring	132305	1	23	Ball Bearing	112040	1
3	O-Ring	174494	1	24	Coupling nut	132348	1
4	Air Regulator	132307	1	25	Lock Ring	110716	1
5	Valve Spring	110773	1	26	Coupling	132339	1
6	Valve Stem	132309	1	27	Coupling Nut	132350	1
7	O-Ring	174495	1	28	Retainer Ring	132351	1
8	O-Ring	132310	1	29	Ball Bearing	141852	1
9	Motor Housing	132326	1	30	Housing Cap	110717	1
10	Valve Bushing	110756	1	31	Spindle Housing 5"	132341	1
11	Standard Lever	110779	1	32	Spindle 5"	128142	1
11S	Safety Lever	117793	1	33	Ball Bearing	141851	2
12	Lever Pin	110780	1	34	Ball Bearing	141847	1
13	Ball Bearing	116008	1	35	Collet Body	117898	1
14	Rear Bearing Plate	132327	1	36	Collet Insert	124270	1
15	Locating Pin	110764	3	37	Collet Nut	97881	1
16	Cylinder	110759	1	38	Muffler	112830	1
17	Rotor Blade	108929	4	39	Retainer ring	112831	1
18	Rotor	110760	1	40	Air Inlet	132313	1
19	Rotor Collar	132318	1	41	Wrench	110725	1
20	Steel Plate	110767	1	42	Wrench	110726	1
21	Front Bearing Plate	132273	1				