

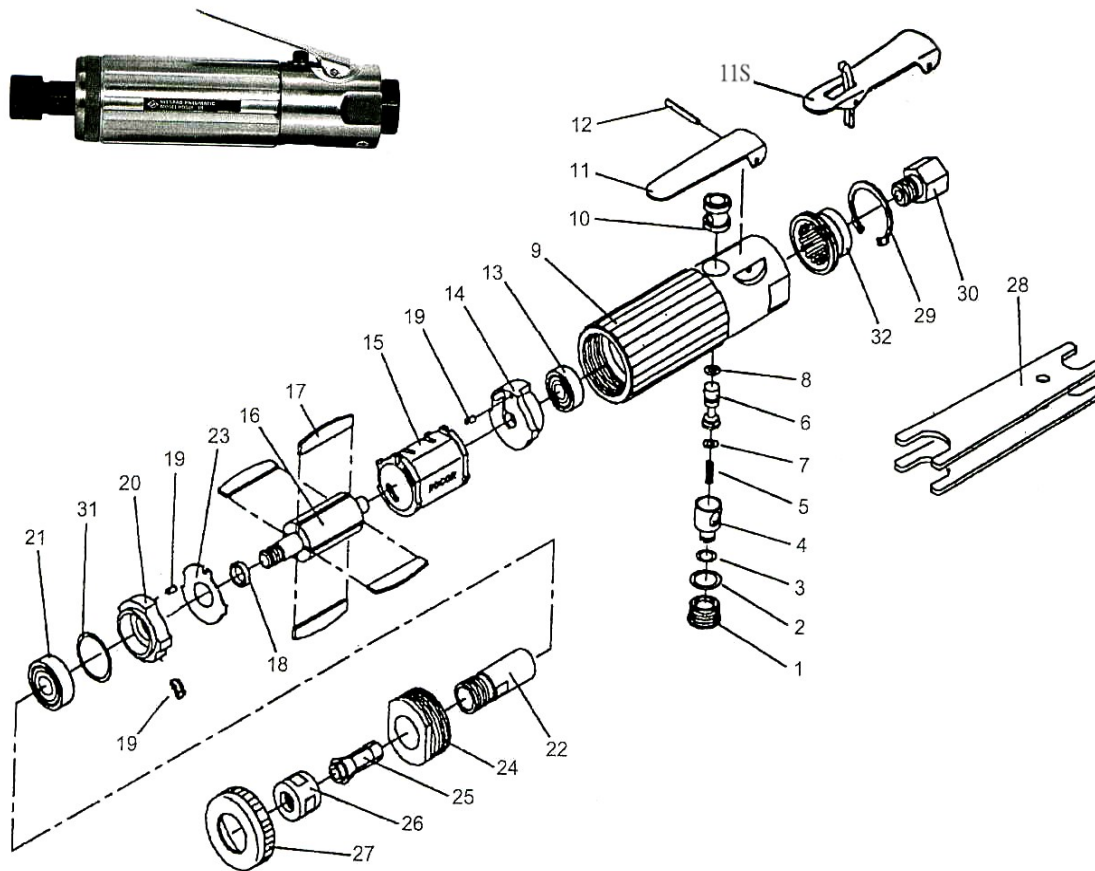

HDG22-6RL & 6RS

HEAVY DUTY DIE GRINDER

Wespro Pneumatic Tools



<u>No.</u>	<u>Description</u>	<u>Order Code</u>	<u>Qty</u>	<u>No.</u>	<u>Description</u>	<u>Order Code</u>	<u>Qty</u>
1	Plug Assembly	117859	1	17	Rotor Blade	110731	4
2	O-Ring	132362	1	18	Spacer	110732	1
3	O-Ring	132306	1	19	Locating Pin	110764	3
4	Air Regulator	117858	1	20	Front Bearing Plate	110734	1
5	Valve Spring	110773	1	21	Ball Bearing	112080	1
6	Valve Stem	117857	1	22	Collet Body	117897	1
7	O-Ring	132308	1	23	Steel Plate	110738	1
8	O-Ring	132363	1	24	Lock Ring	132358	1
9	Motor Housing	132355	1	25	Collet Insert	124269	1
10	Valve Bushing	110777	1	26	Collet Nut	83891	1
11	Standard Lever	110779	1	27	Thread Guard	135697	1
11S	Safety Lever	117792	1	28	Wrench	110743	2
12	Lever Pin	110780	1	29	Retainer Ring	132360	1
13	Ball Bearing	112040	1	30	Air Inlet	132361	1
14	Rear Bearing Plate	132356	1	31	Shim Pack	132371	0-2
15	Cylinder	110729	1	32	Muffler	132359	1
16	Rotor	110730	1				