

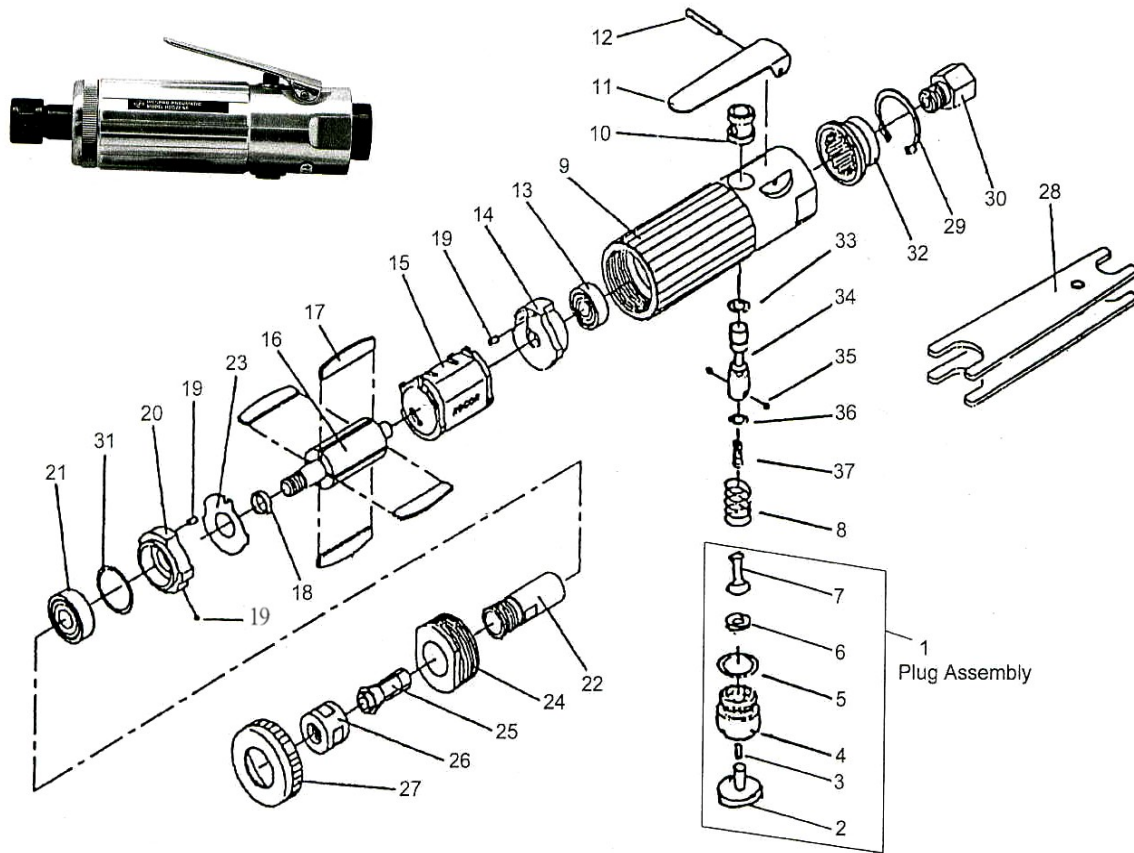

**HDG22-6RB**

**HEAVY DUTY DIE GRINDER**

**Wespro Pneumatic Tools**



<u>No.</u>	<u>Description</u>	<u>Order Code</u>	<u>Qty</u>	<u>No.</u>	<u>Description</u>	<u>Order Code</u>	<u>Qty</u>
1	Plug Assembly	110771	1	20	Front Bearing Plate	110734	1
2	Plug	135696	1	21	Ball Bearing	112080	1
3	Pin	143334	1	22	Collet Body	117897	1
4	Plug Screw	143335	1	23	Steel Plate	110738	1
5	O-Ring	143336	1	24	Lock Ring	132358	1
6	PU Seal	110737	1	25	Collet Insert	124269	1
7	Stem	143337	1	26	Collet Nut	83891	1
8	Spring	110772	1	27	Thread Guard	110742	1
9	Motor Housing	132355	1	28	Wrench	110743	2
10	Valve Bushing	110777	1	29	Retainer Ring	132360	1
11	Standard Lever	110779	1	30	Air Inlet	132361	1
12	Lever Pin	110780	1	31	Shim Pack	132371	0-2
13	Ball Bearing	112040	1	32	Muffler	132359	1
14	Rear Bearing Plate	132356	1	33	O-Ring	110775	1
15	Cylinder	110729	1	34	Valve	110774	1
16	Rotor	110730	1	35	Steel Ball	110753	2
17	Rotor Blade	110731	4	36	O-Ring	116340	1
18	Spacer	110732	1	37	Spring	143338	1
19	Locating Pin	110764	3				